

10. SCHEMATIC DIAGRAM 10-1. Amp. Section

*Design and specifications subject to change without notice for improvement.
 *La présentation et les spécifications sont susceptibles d'être modifiées sans préavis par suites d'améliorations éventuelles.
 *Änderungen, die dem technischen Fortschritt dienen, bleiben vorbehalten.

*On the F-3816 circuit board, L-ch is specified by "○" or "◊" mark on top of the parts No.

*On the F-3817, F-3818 circuit board, L-ch is specified by "●" mark on top of the parts No.

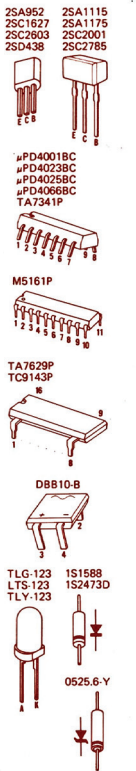
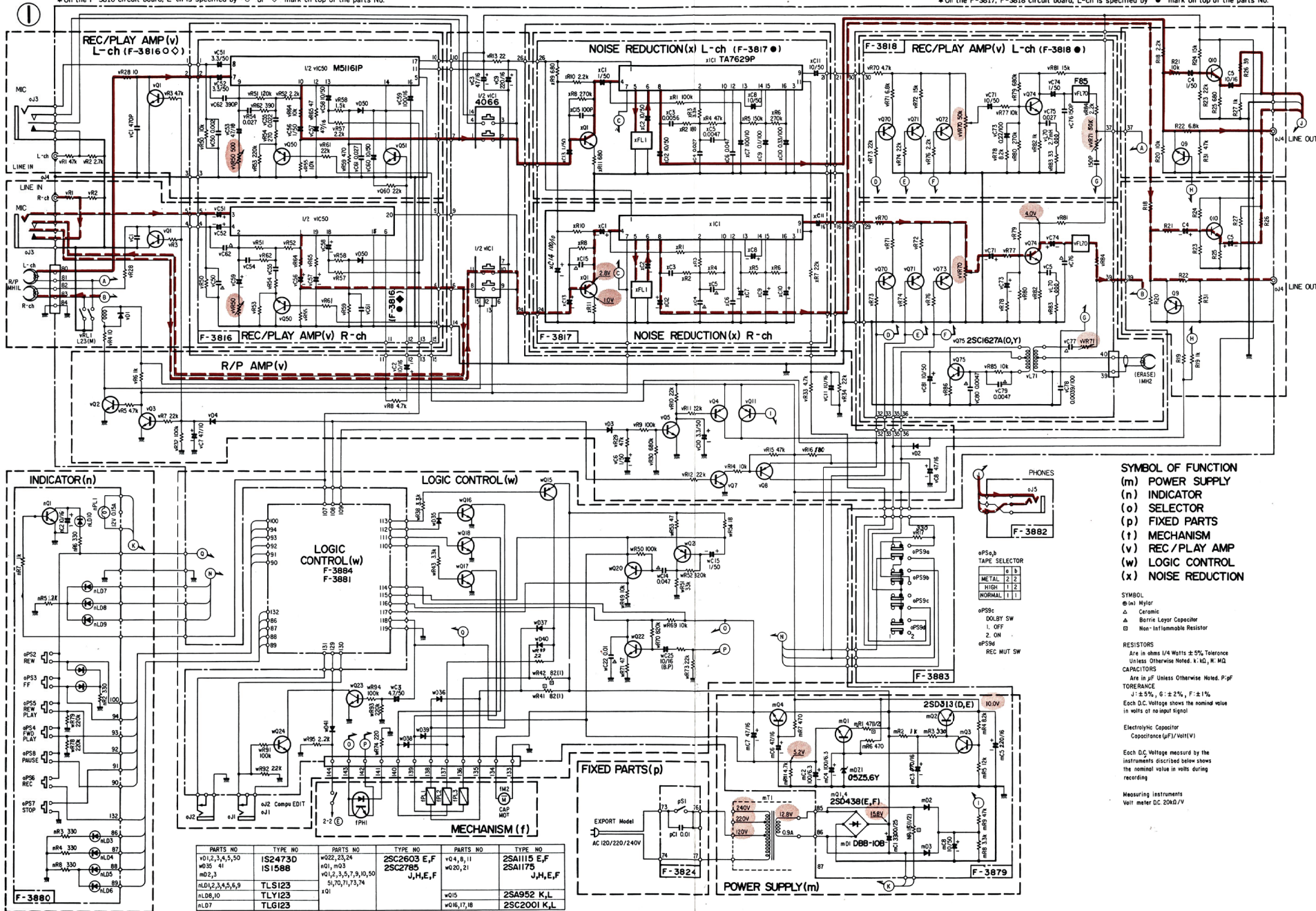

- SYMBOL OF FUNCTION**
- (m) POWER SUPPLY
 - (n) INDICATOR
 - (o) SELECTOR
 - (p) FIXED PARTS
 - (f) MECHANISM
 - (v) REC/PLAY AMP
 - (w) LOGIC CONTROL
 - (x) NOISE REDUCTION

- SYMBOL**
- ⊙ (m) Mylar
 - △ (n) Ceramic
 - ▲ (p) Barrie Layer Capacitor
 - ⊠ (o) Non-Inductance Resistor
- RESISTORS**
- Are in ohms 1/4 Watts ±5% Tolerance
 Unless Otherwise Noted. K: kΩ, M: MΩ
- CAPACITORS**
- Are in μF Unless Otherwise Noted. P: pF
 TOLERANCE:
 J: ±5%, G: ±2%, F: ±1%
 Each D.C. Voltage shows the nominal value in volts at no input signal
- Electrolytic Capacitor**
 Capacitance (μF)/VOLT(V)
- Each D.C. Voltage measured by the instruments described below shows the nominal value in volts during recording
- Measuring Instruments**
 Volt meter DC 20kΩ/V

PARTS NO	TYPE NO	PARTS NO	TYPE NO	PARTS NO	TYPE NO
v01,2,3,4,5,50	IS2473D	w022,23,24	25C2603 E,F	w04,8,11	25A1115 E,F
w035 41	IS1588	m01, m03	25C2785	w020,21	25A1175
m02,3		v01,2,3,5,7,9,10,50			J,H,E,F
RLD1,2,3,4,5,6,9	TLG123	v01		w015	25A952 K,L
RLD8,10	TLY123			w016,17,18	25C2001 K,L
RLD7	TLG123				

OPTIONAL USE OF SEMICONDUCTOR

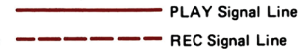

10-2. Mechanism Control Section

*Design and specifications subject to change without notice for improvement.
 *La présentation et les spécifications sont susceptibles d'être modifiées sans préavis par suites d'améliorations éventuelles.
 *Änderungen, die dem technischen Fortschritt dienen, bleiben vorbehalten.

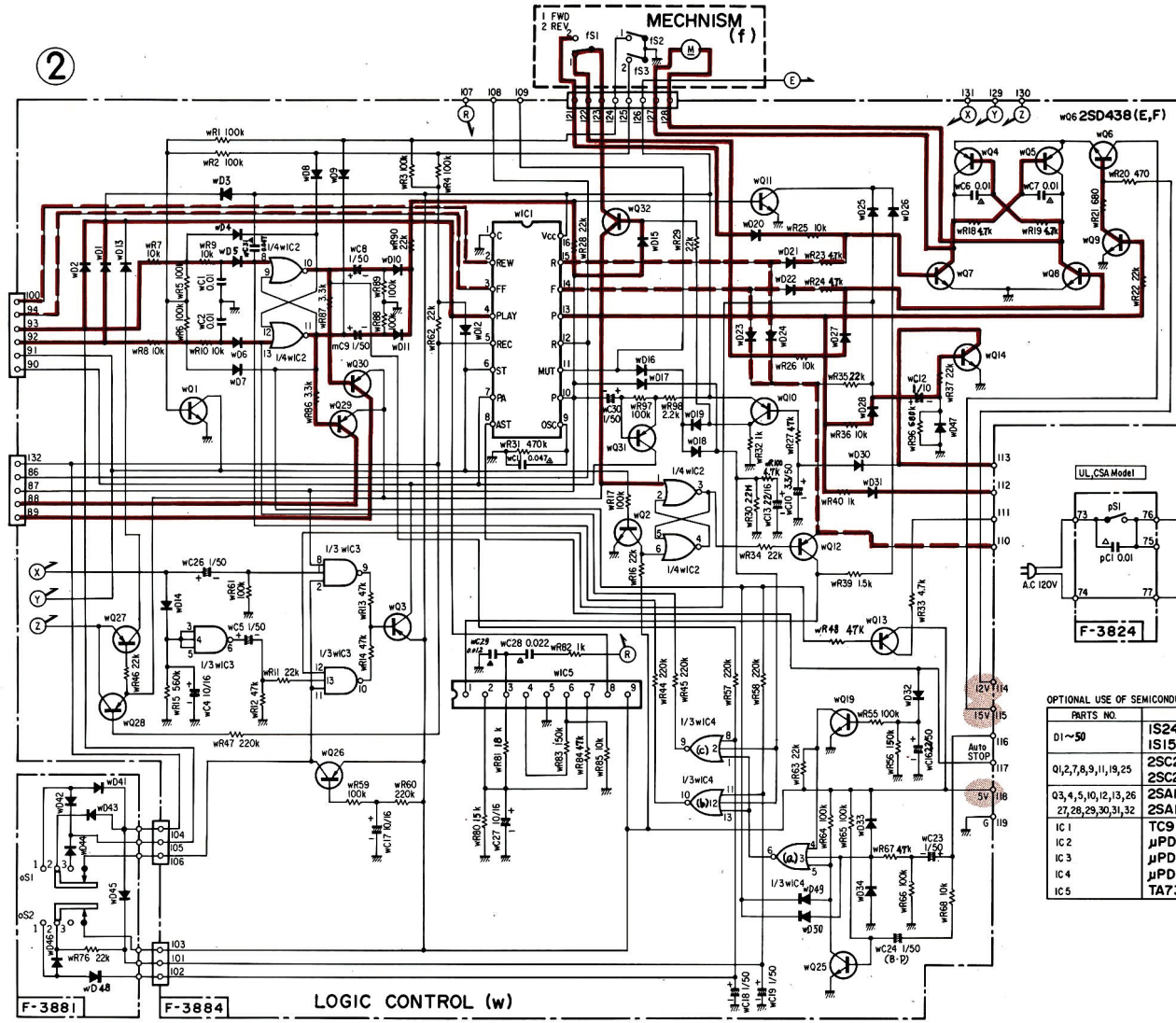

- S1, TIMER SW
- 1, REC
- 2, OFF Compu EDIT on
- 3, PLAY
- S2, REVERSE MODE SW
- 1, U
- 2, O
- 3, U

— FWD and REV PLAY Line
 - - - FF-REW Line

OPTIONAL USE OF SEMICONDUCTOR

PARTS NO.	TYPE NO.
D1~50	IS2473D IS1588
Q1,2,7,8,9,11,19,25	2SC2603 E,F 2SC2785 J,H,F,E
Q3,4,5,10,12,13,26 27,28,29,30,31,32	2SA1115 E,F 2SA1175 J,H,F,E
IC1	TC9143P
IC2	μPD4001
IC3	μPD4023
IC4	μPD4025
IC5	TA7341P

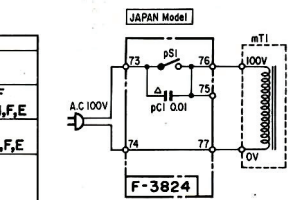
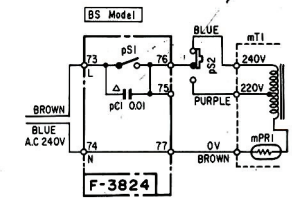
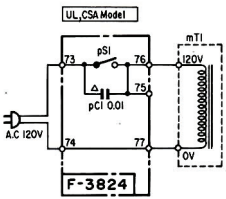
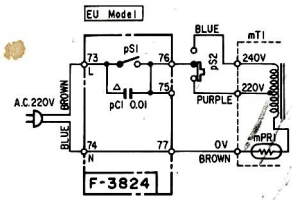
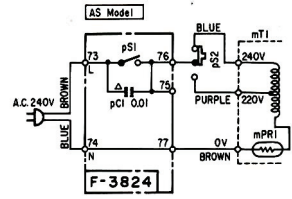

- 2SA952
- 2SC1627
- 2SC2603
- 2SD438
- 2SA1115
- 2SA1175
- 2SC2001
- 2SC2785

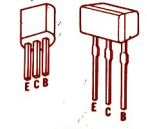

- μPD4001BC
- μPD4023BC
- μPD4025BC
- μPD4066BC
- TA7341P



M5161P

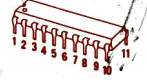

- TA7629P
- TC9143P



DBB10-B



- TLG-123
- LTS-123
- TLY-123
- IS1588
- IS2473D

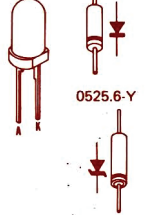

0525.6-Y